

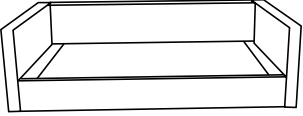



ASSEMBLY INSTRUCTION

S151-3SS

Parts List

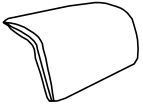
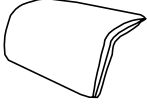
A, 1 PC sofa base	B, 2 pcs seat cushion	C, 2 pcs back cushion	
			
D, 1 pc left arm cushion	E, 1 pc right arm cushion	F, 4 pcs plastic washer	G, 4 pcs plastic leg
			

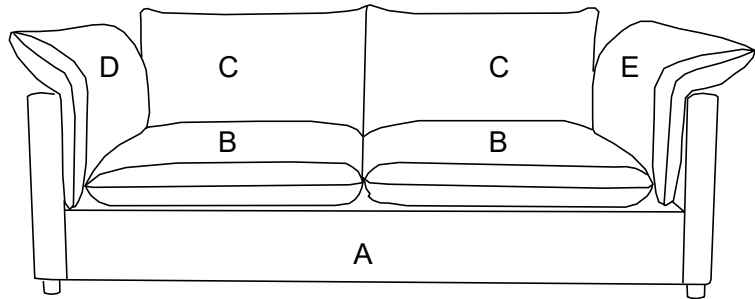
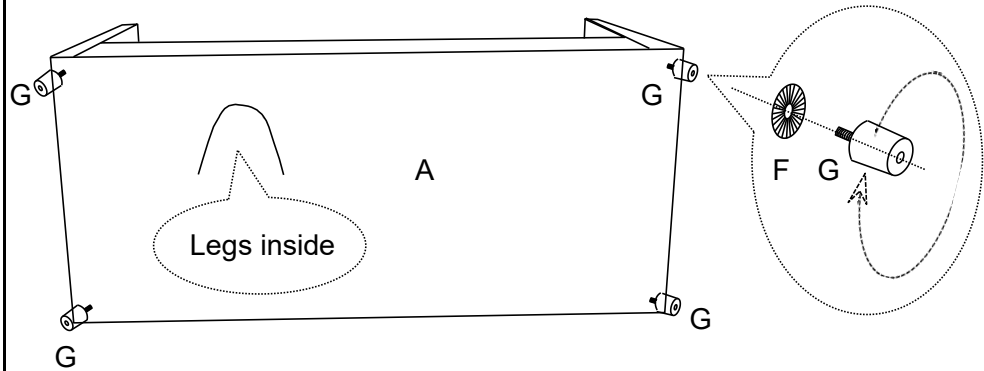





Two person required.

ASSEMBLY INSTRUCTION

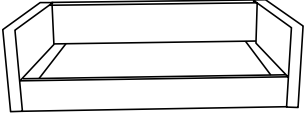
S151-3SS

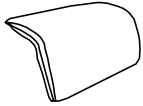
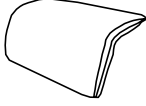
Parts List

A, 1 PC sofa base	B, 2 pcs seat cushion	C, 2 pcs back cushion	
			
D, 1 pc left arm cushion	E, 1 pc right arm cushion	F, 4 pcs plastic washer	G, 4 pcs plastic leg
			

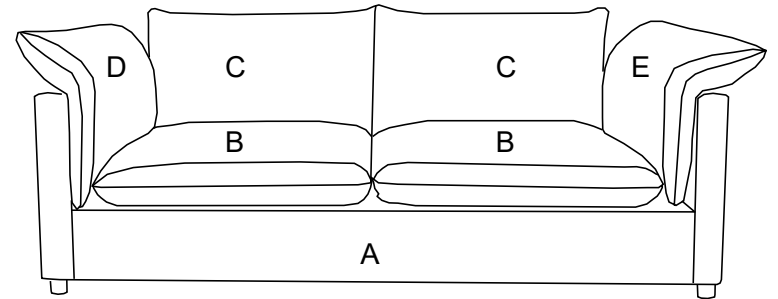
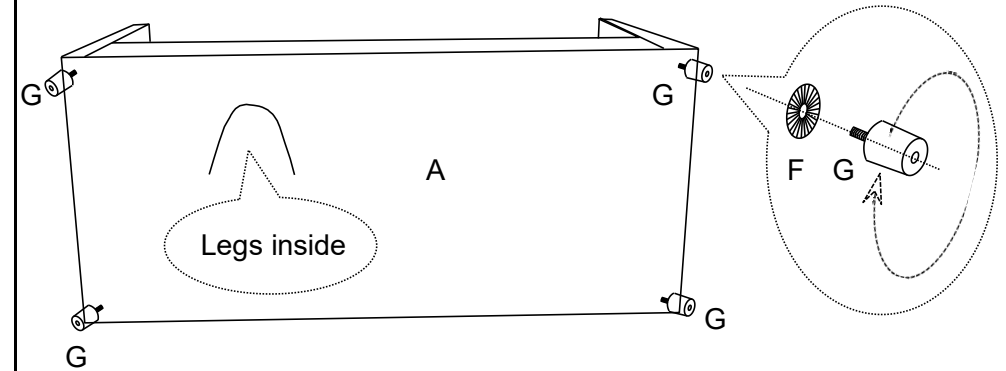





Two person required.

ASSEMBLY INSTRUCTION

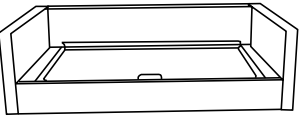
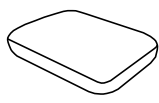
S151-68X

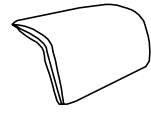
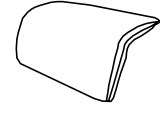
Parts List

A, 1 PC sofa bed	B, 2 pcs seat cushion	C, 2 pcs back cushion	D, 1 pc left arm cushion	E, 1 pc right arm cushion	F, 4 pcs plastic washer	G, 4 pcs plastic leg
						

Step 1, Assemble the F/G at the bottom of A .

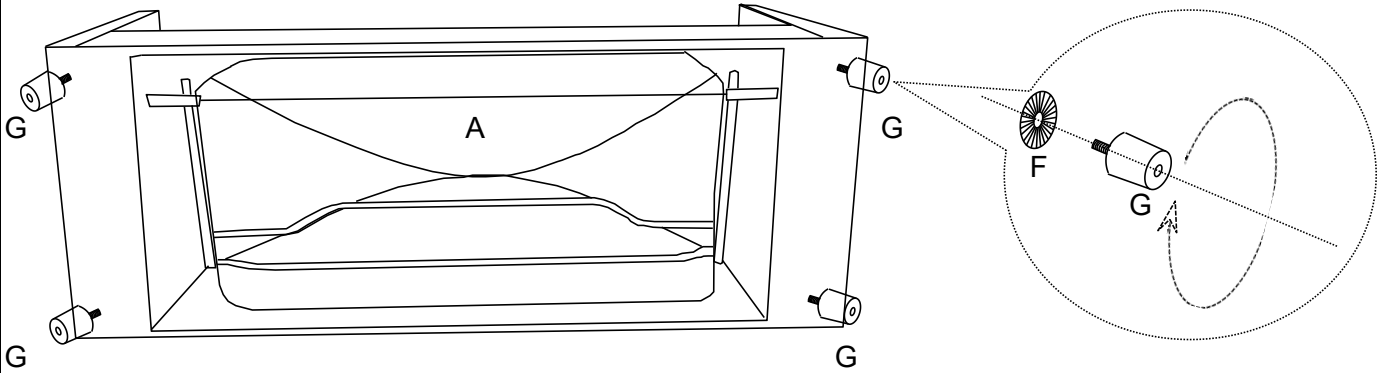

Step 2, Unfasten the Nylon cable tie which secure the folded bed .

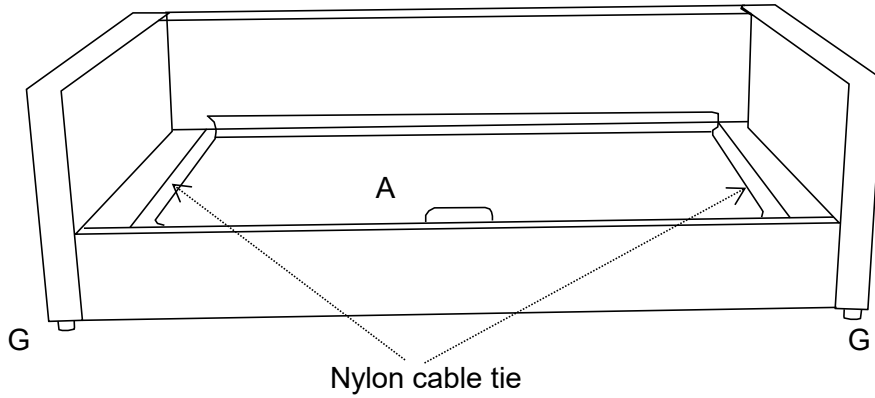

Step 3, Place B/C/D/E at the correct positions

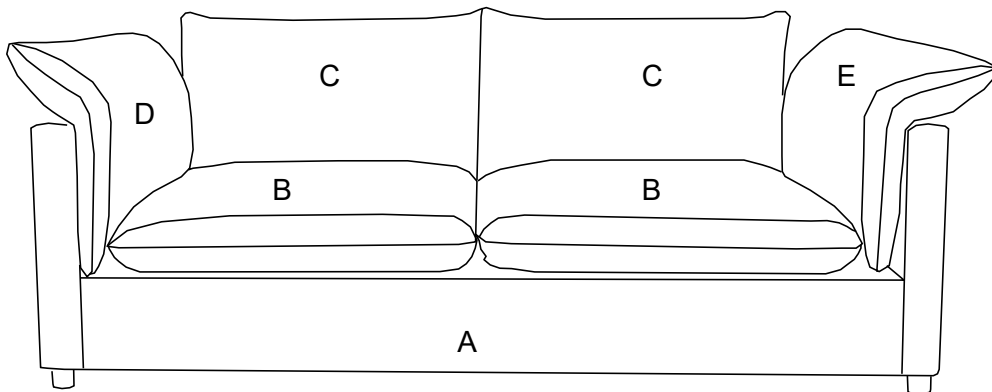

Two person required.