

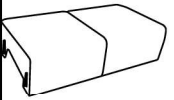
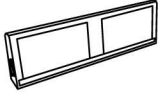
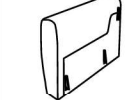
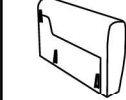
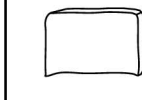

ASSEMBLY INSTRUCTION

S153K-3SS

Parts list

A, 1 pc seat cushion	B, 1 pc back frame	C, 1pc left side armrest	D, 1pc right side armrest	E, 2 pcs back cushion	F, 4pcs plastic washer	G, 4 pcs plastic leg
						

Step 1,
Assemble the
F&G at the
bottom of C
and D.

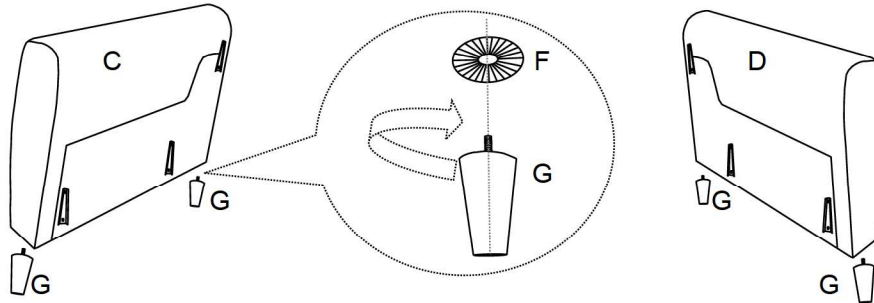

Step 2, Connect the A/B/C/D.

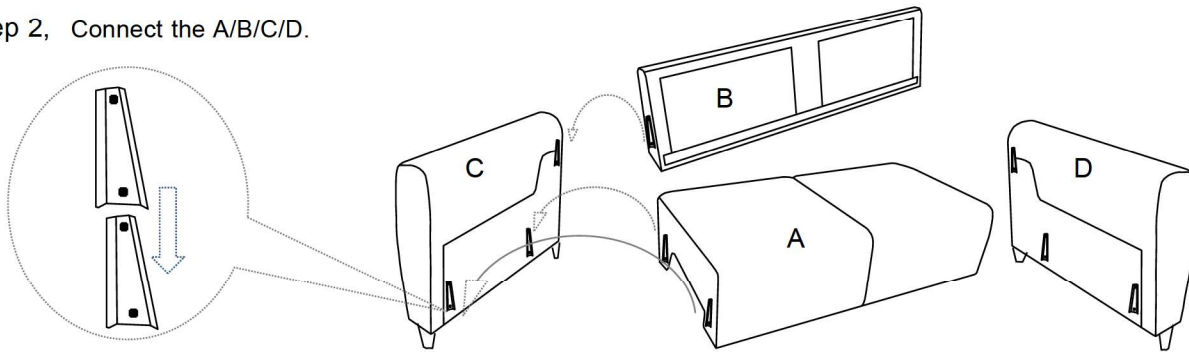

Step 3, Connect the velcro tapes from A to B.

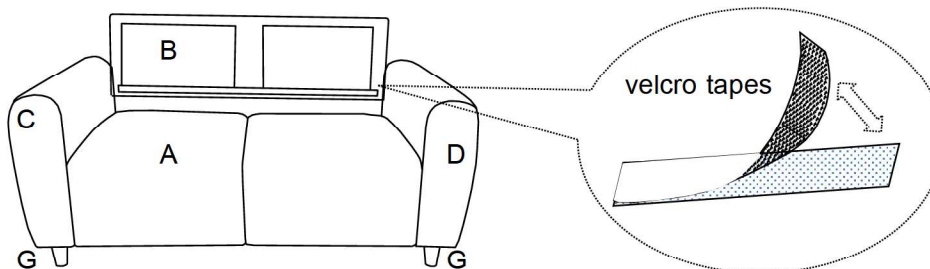

Step 4, Completed.

