

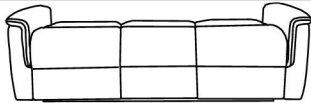

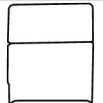

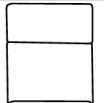

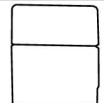

ASSEMBLY INSTRUCTION

M209

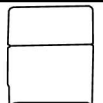
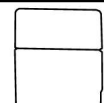
Parts List

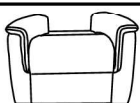
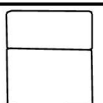
BOX 1	A, 1 PC 3 Seater	B, 1PC left side backrest	C, 1PC center backrest	D, 1PC right side backrest	E, 1 PC Adapter	F, 1 PC Power Cord
						
BOX 2	G, 1 PC 2 Seater	H, 1PC left side backrest	J, 1PC right side backrest	E, 1 PC Adapter	F, 1 PC Power Cord	
						
BOX 3	K, 1 PC 1 Seater	L, 1PC Backrest	E, 1 PC Adapter	F, 1 PC Power Cord		
						

Step1, Take out the package of power cord (F) and adapter(E).

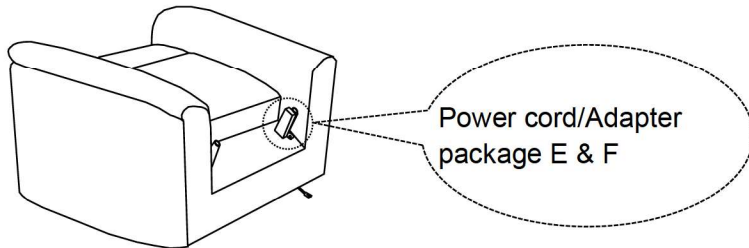

Step2, Assemble the backrest.

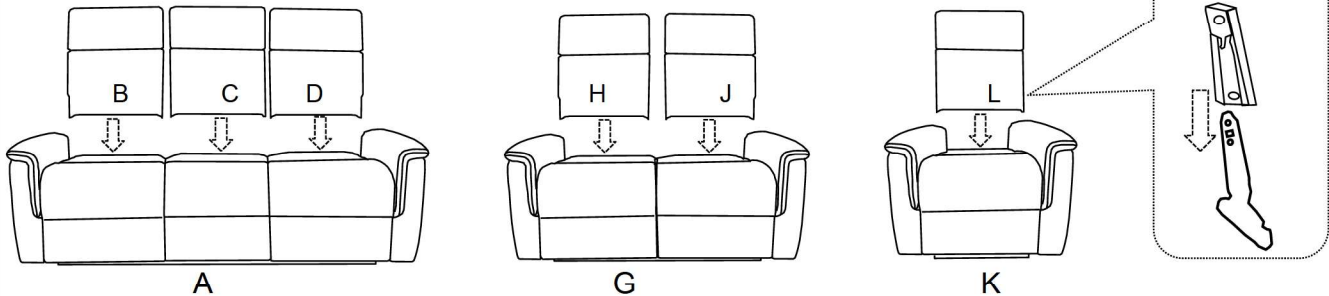

Step3, Plug the Power Cord(F) into the Adapter(E), connect the wire from the seat into the adapter(E).

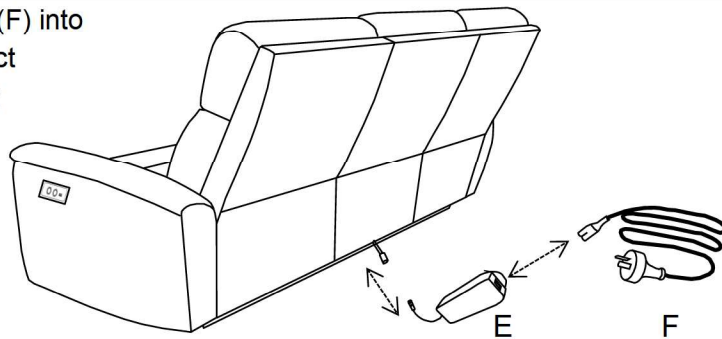

Step4, Complete.

