

| Panel No | Panel Sizes | Quantity |
|----------|-------------|----------|
| 1 | 810*400*25 | 1 |
| 2 | 810*400*25 | 1 |
| 3 | 1142*398*25 | 1 |
| 4 | 1142*398*25 | 1 |
| 5 | 1142*398*16 | 1 |

| Panel No | Panel Sizes | Quantity |
|----------|-------------|----------|
| 6 | 1142*398*16 | 1 |
| 7 | 370*396*16 | 4 |
| 8 | 370*396*16 | 1 |
| 9 | 370*396*16 | 1 |
| 10 | 370*370*16 | 2 |

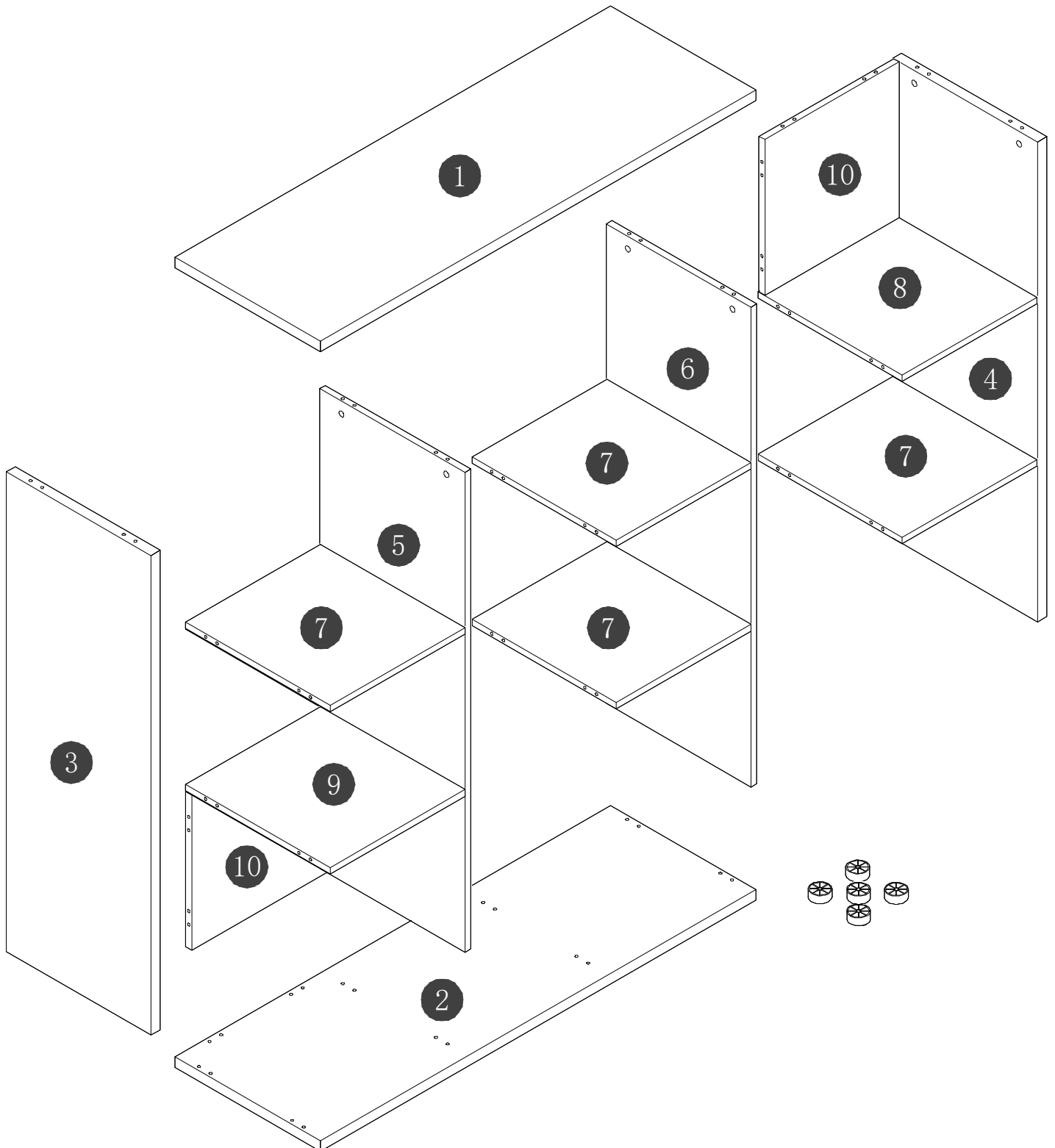

Fittings



M6*40

A=48

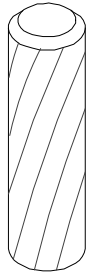

Φ 8*30

B=56

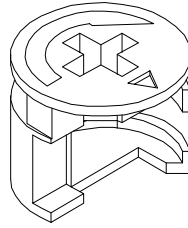

Φ 15*12

C=48



Φ 21

D=48

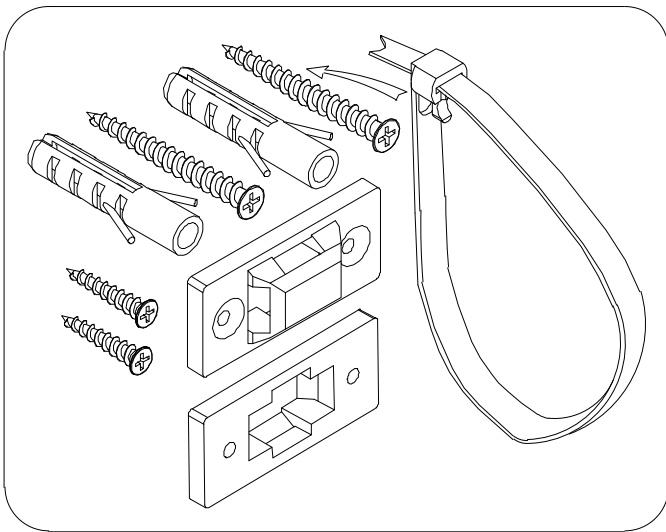

F=1

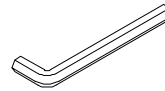

M4

H=1

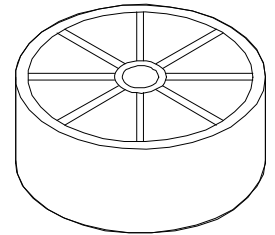

Φ 51*24

J=5

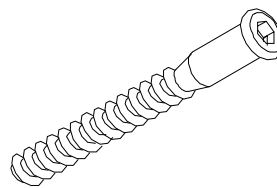

Φ 7*50

Q=8

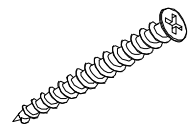

M4*35

V=5

STEP 1

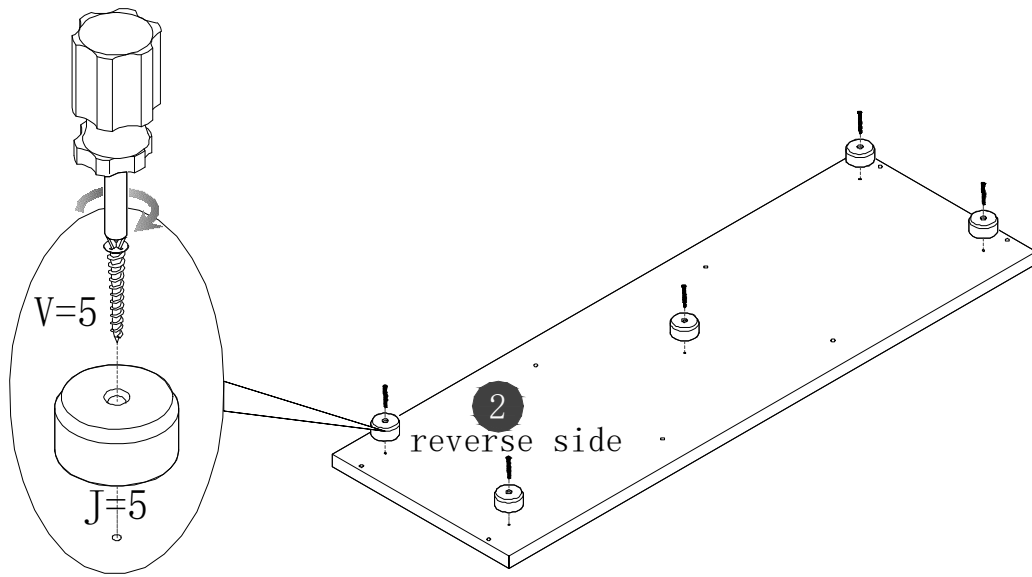

STEP 2

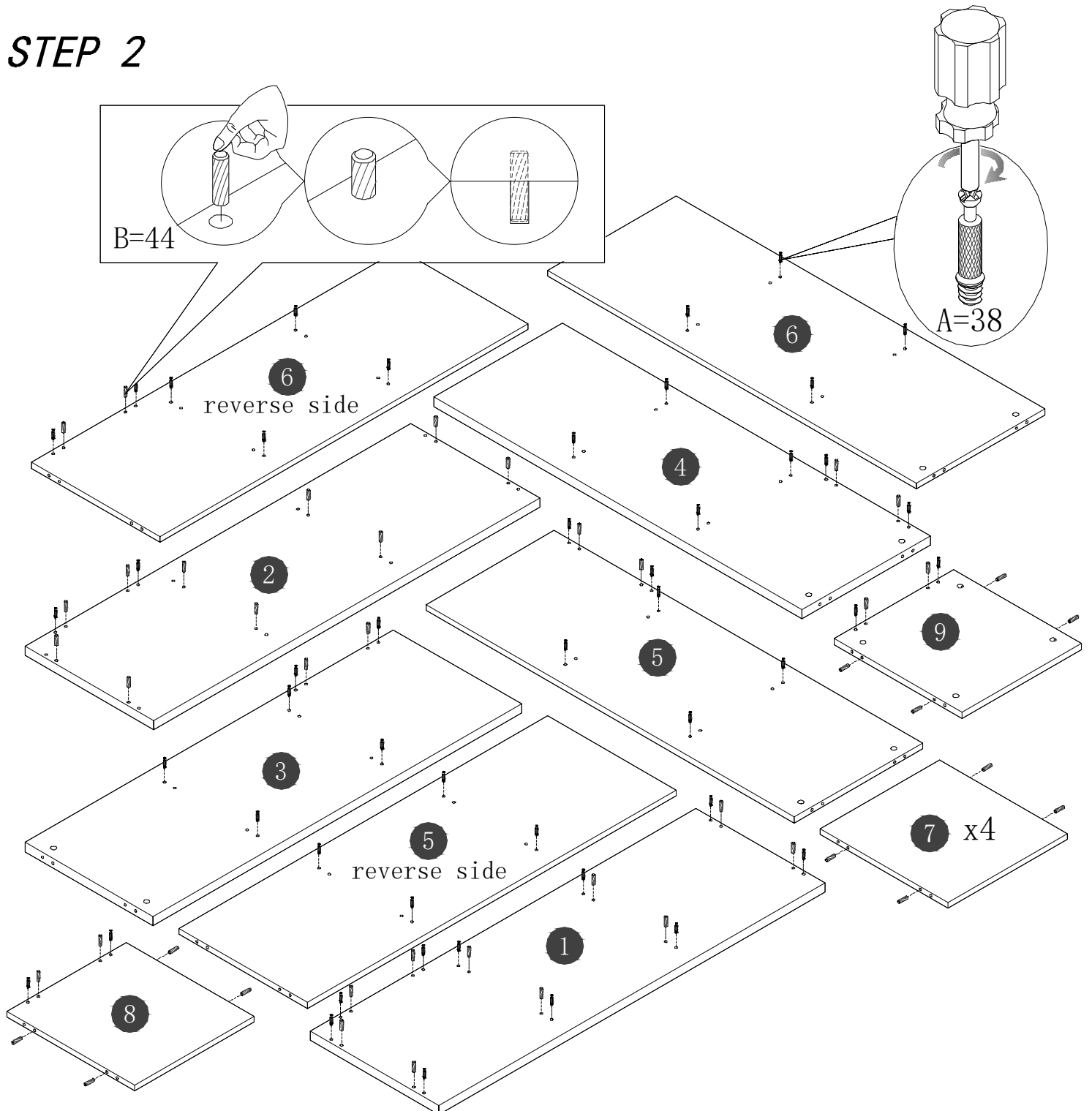

STEP 3

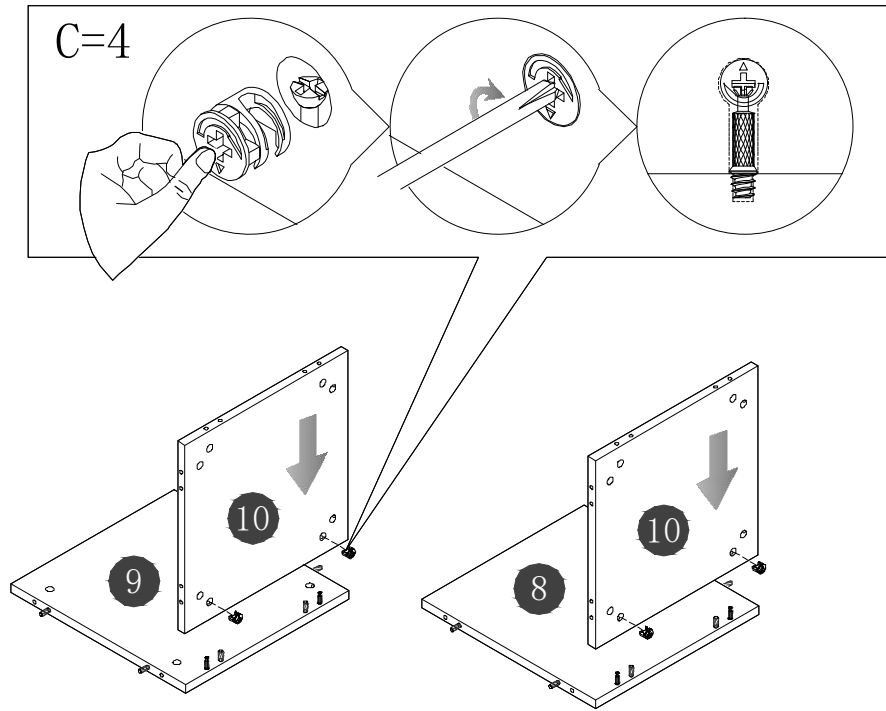

STEP 4

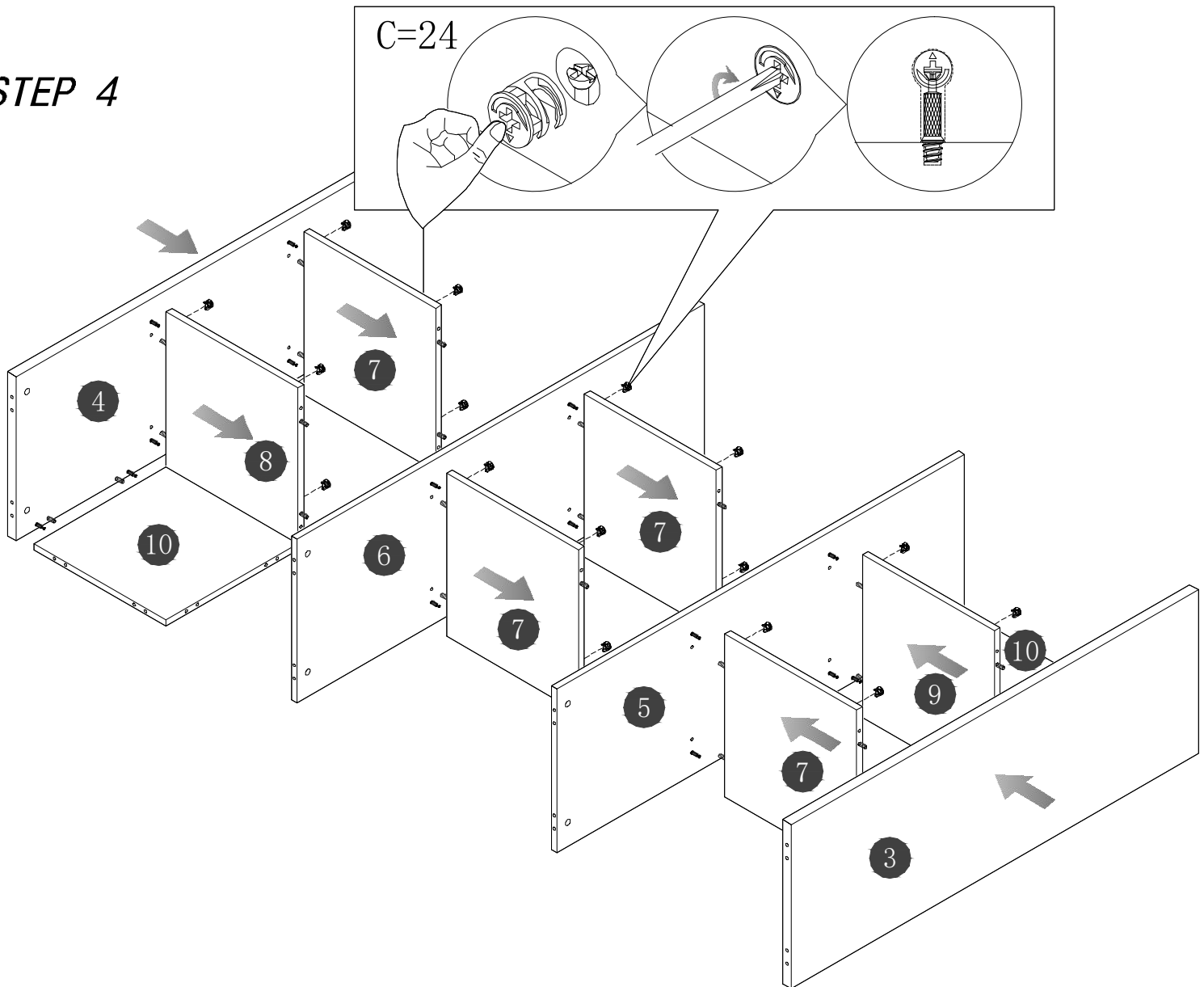

STEP 5

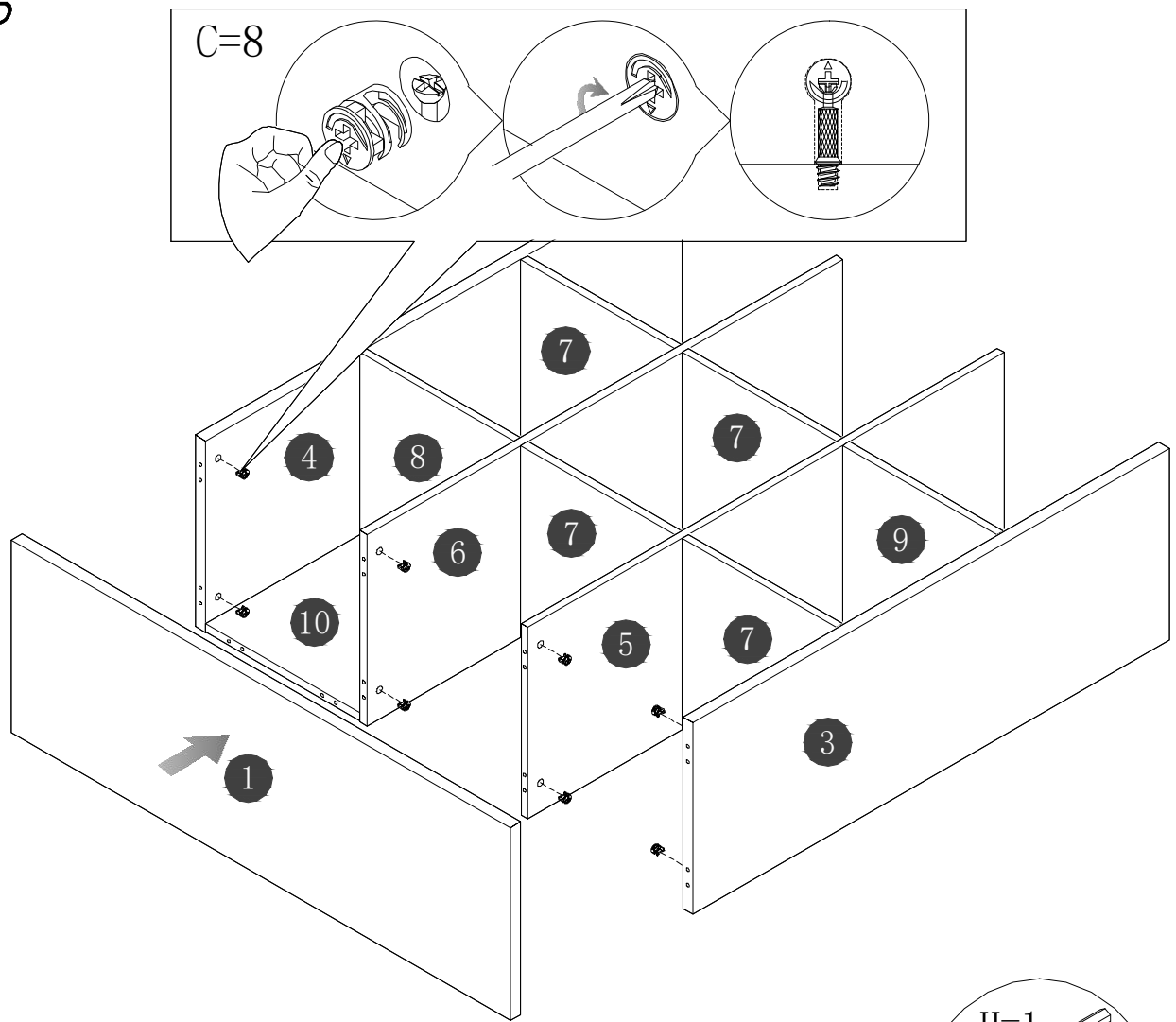

STEP 6

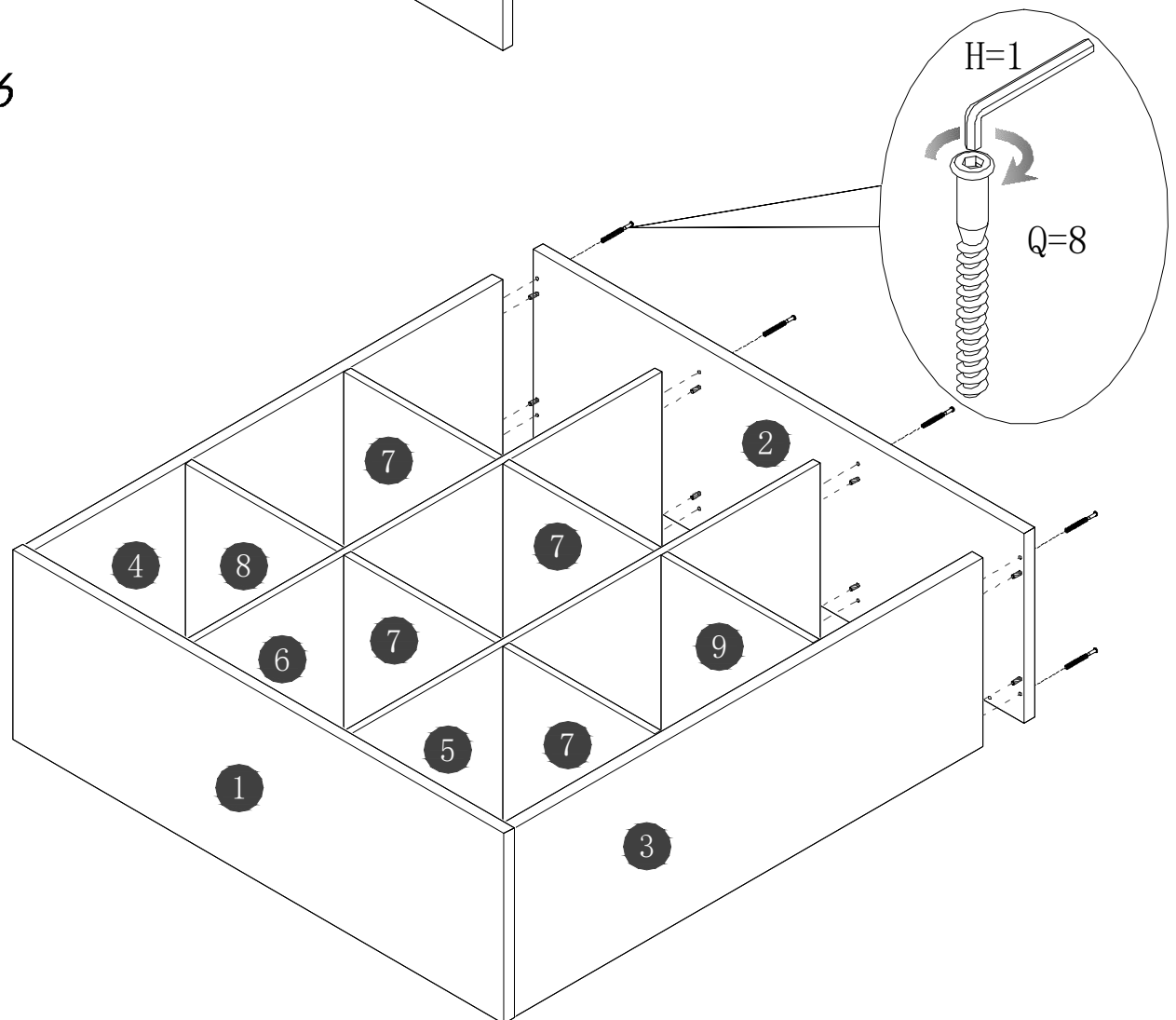

STEP 7

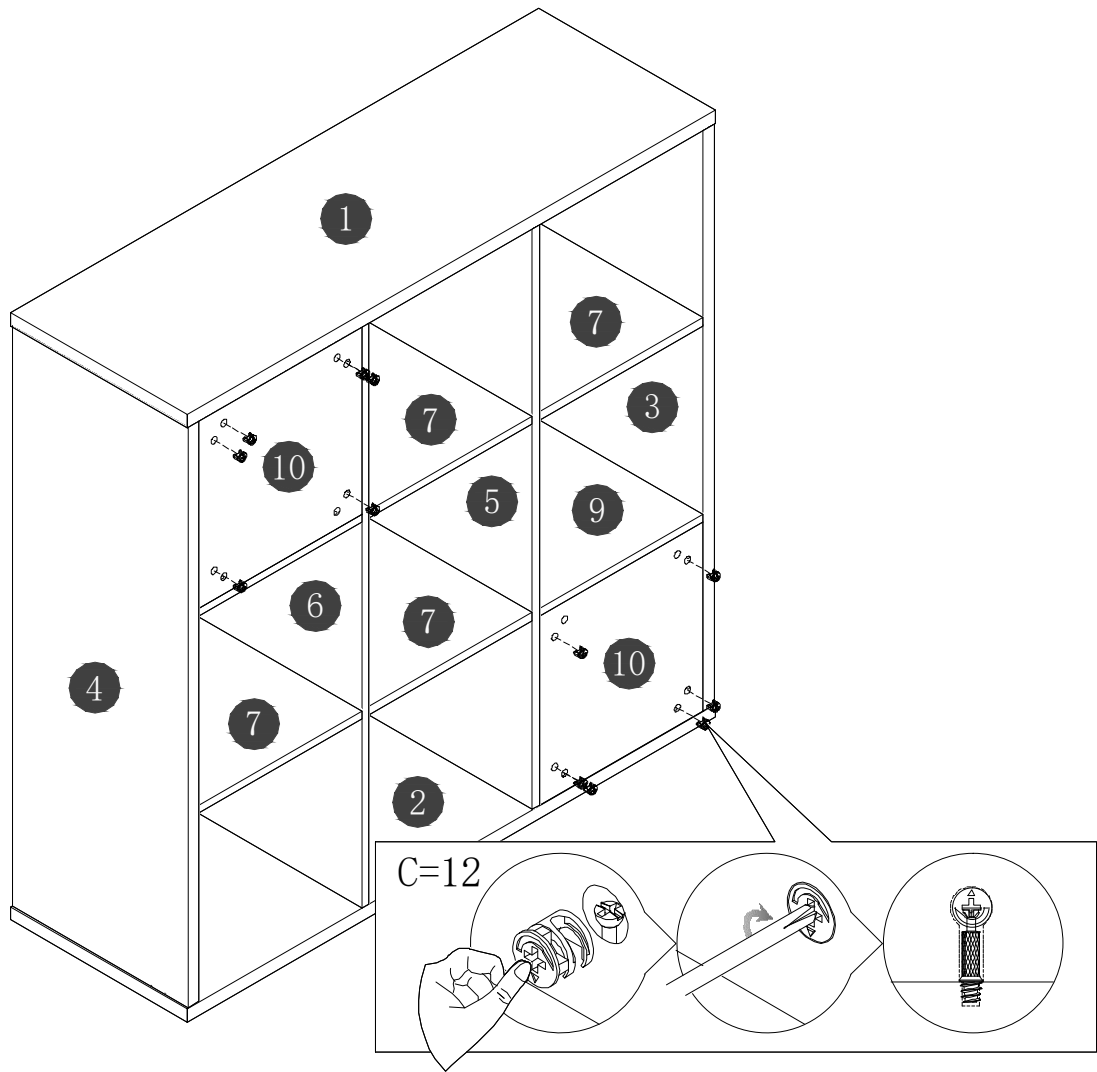

STEP 8

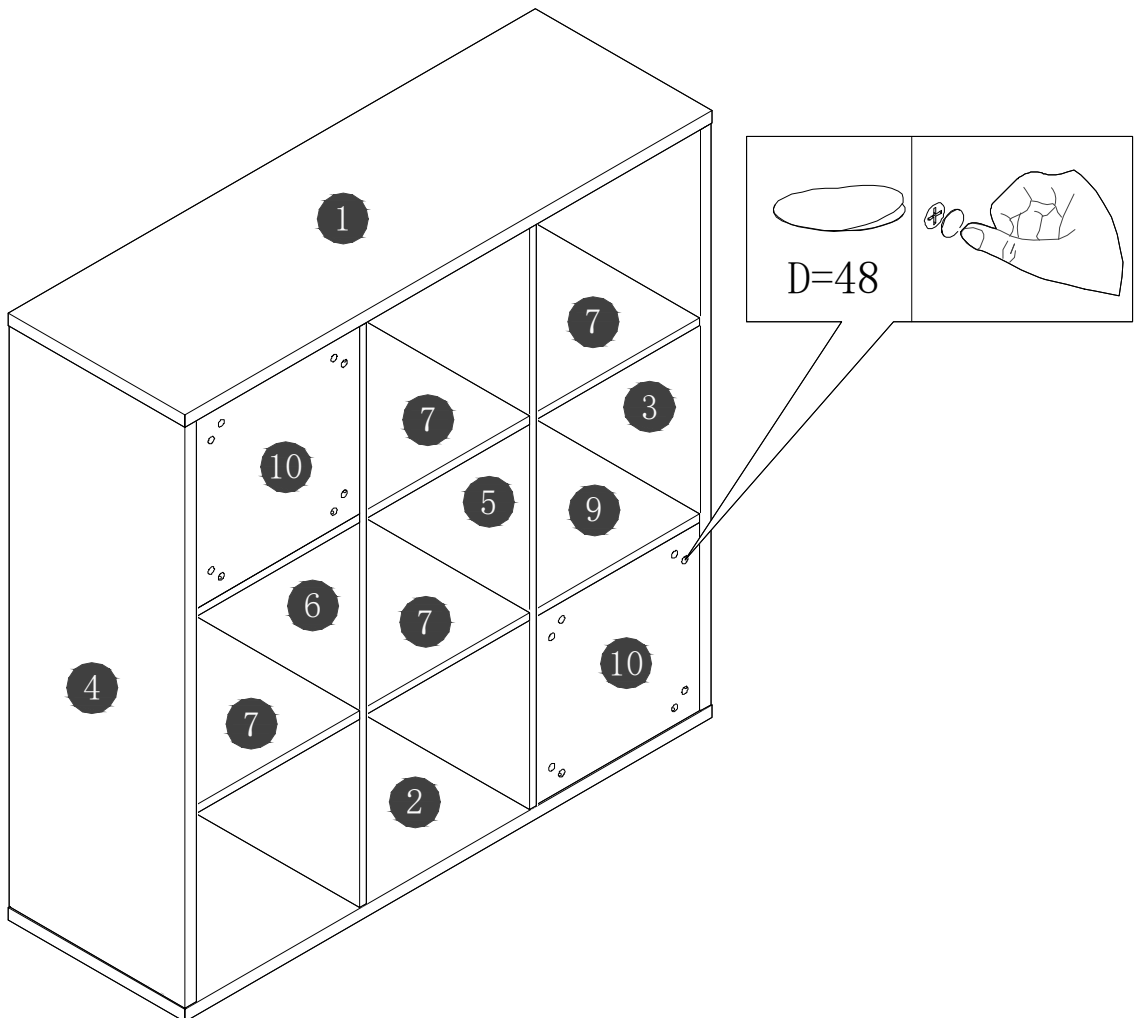

STEP 9

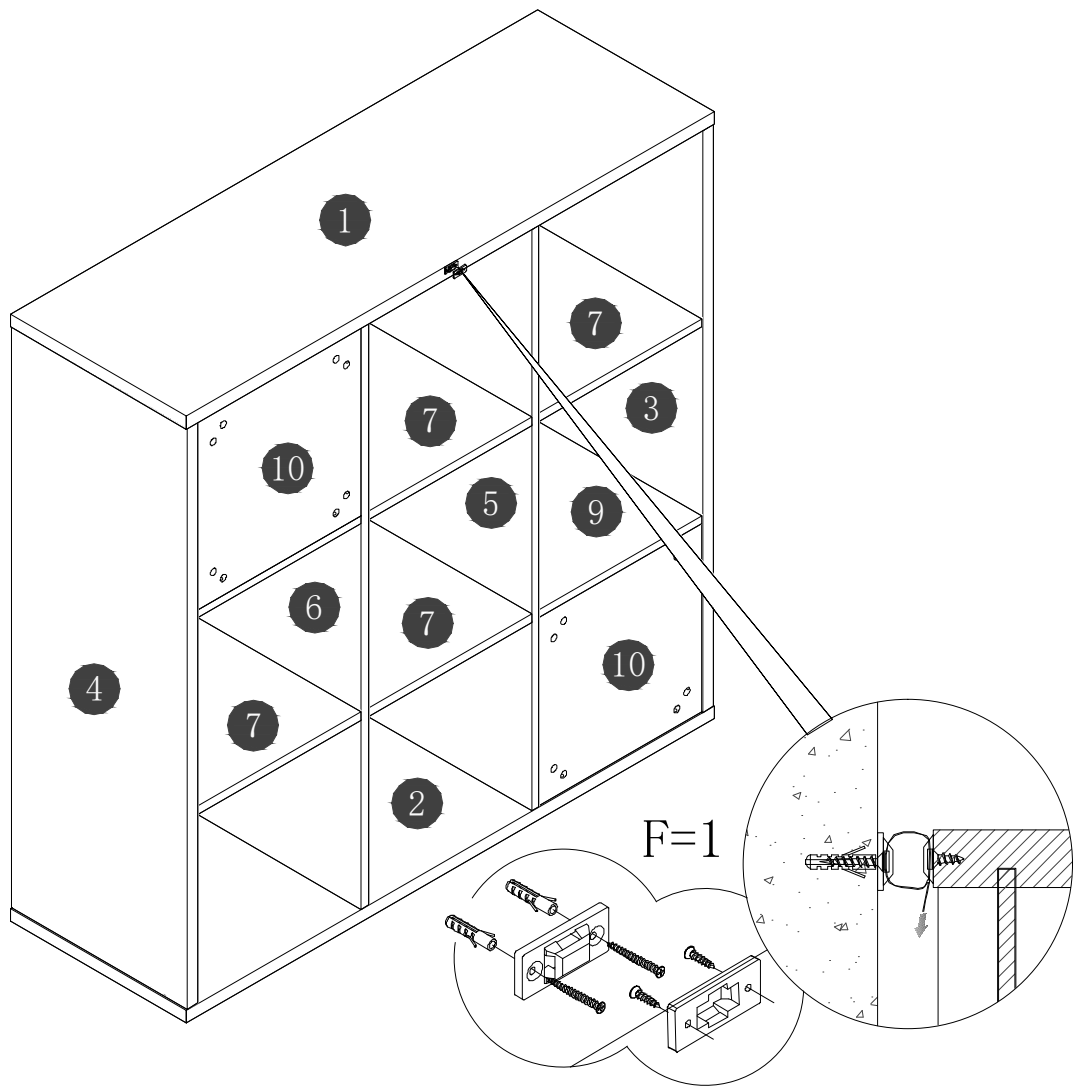

STEP 10

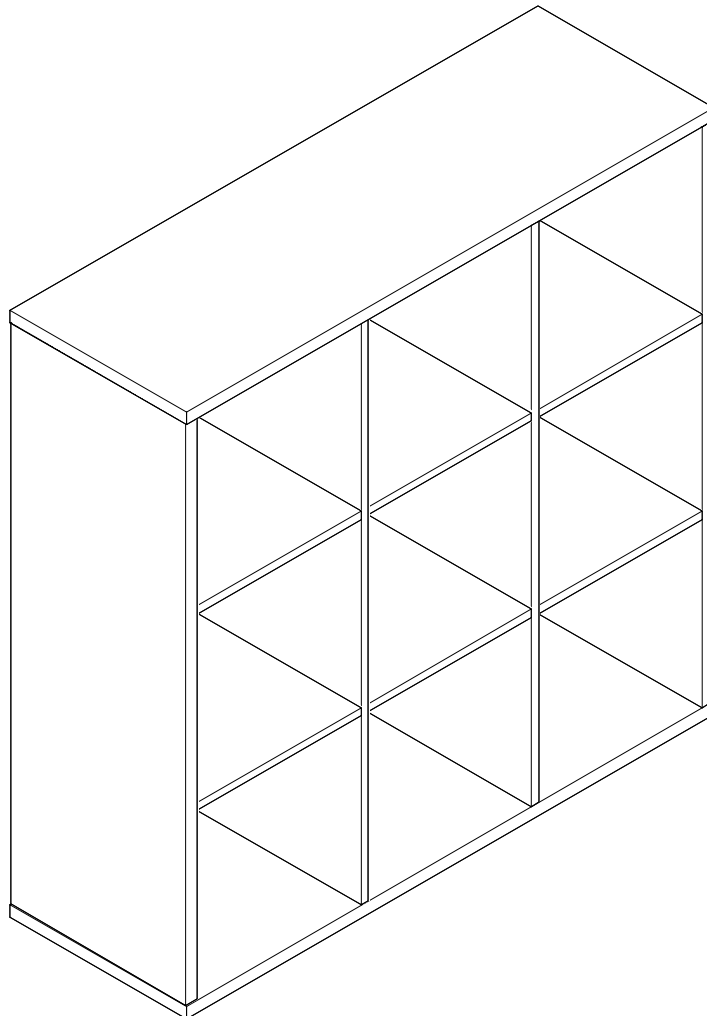

Finish