

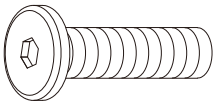

A×6



M6×35mm

B×6



M6

C×6



M6

D×6

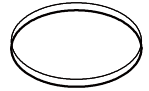





E×1

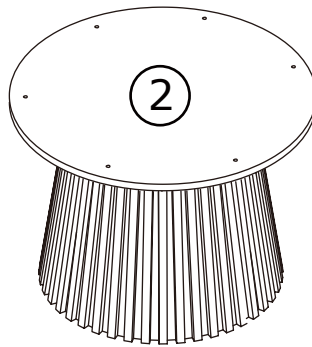
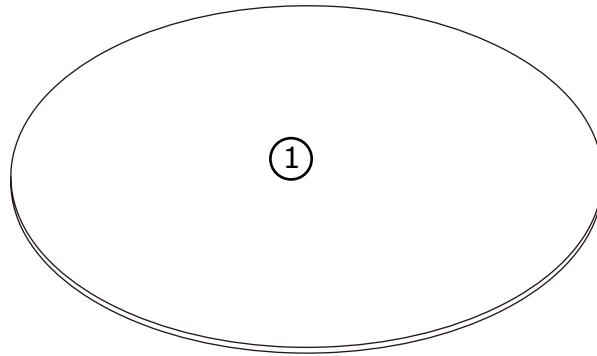

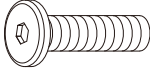
M4



<h1>1</h1>	<p>A×6</p>  <p>M6×35mm</p>	<p>B×6</p>  <p>M6</p>	<p>C×6</p>  <p>M6</p>	<p>D×5</p> 
------------	---	--	--	--

Ex1



M4

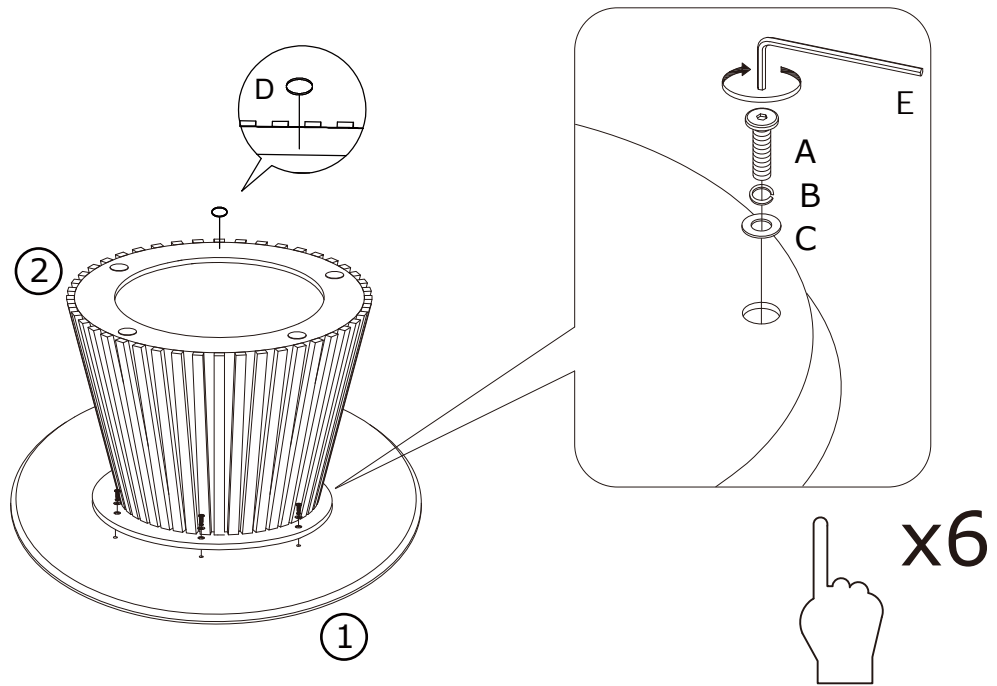

2

