

ASSEMBLY INSTRUCTIONS

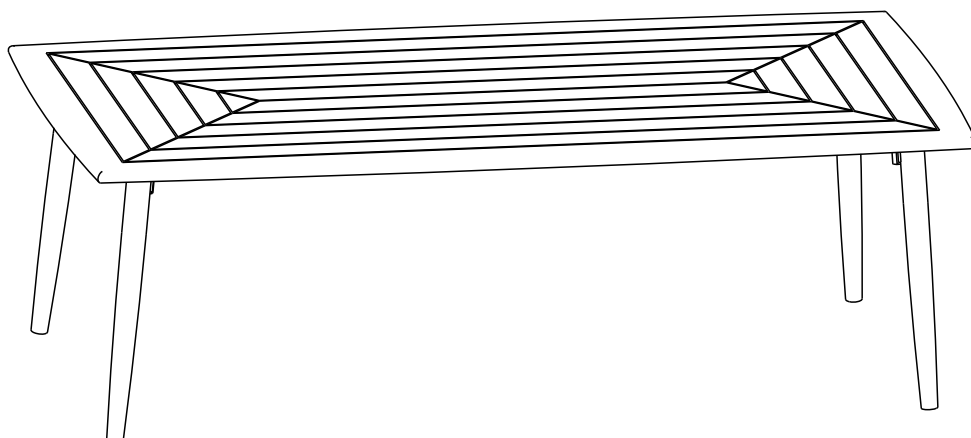

DARIO DINING TABLE 1695 x 895mm

FURNITURE NOT SUITABLE FOR COMMERCIAL USE

PRE-ASSEMBLY PREPARATION

Before you start:

1. Choose a clean, level, spacious assembly area. Avoid hard surfaces that may damage the product.
2. Take care when lifting. Product should be assembled as near as possible to the point of use.
3. Ensure that you have all required contents for complete assembly.
4. Always read the assembly instructions carefully before beginning assembly.
5. The packaging and contents can be a choking hazard, therefore keep out of reach of small children at all time.
6. Do not over tighten the screws and bolts as this may damage the threads.
7. Failure to follow the above instructions may result in damage and or the incorrect assembly of the furniture.





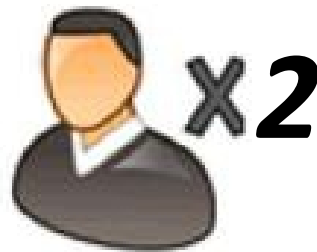



ALLOW 20 MINUTES

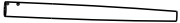

2 PEOPLE REQUIRED

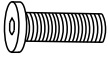
FURNITURE NOT SUITABLE FOR COMMERCIAL USE

COMPONENTS / HARDWARE

A  1pc	B  4pcs	C  8pcs
D  8pcs M8*40	E  8pcs	F  8pcs
G  1pc		

FURNITURE NOT SUITABLE FOR COMMERCIAL USE

STEP 1

PLACE THE TABLE TOP UPSIDE DOWN ON A FLAT, SOFT SURFACE TO AVOID DAMAGE, ALIGN HOLES IN PART B OVER THREADS IN PART A, ATTACH PART B TO PART A USING BOLTS AS SHOWN BELOW. COMPLETELY TIGHTEN ALL BOLTS AT THIS POINT.

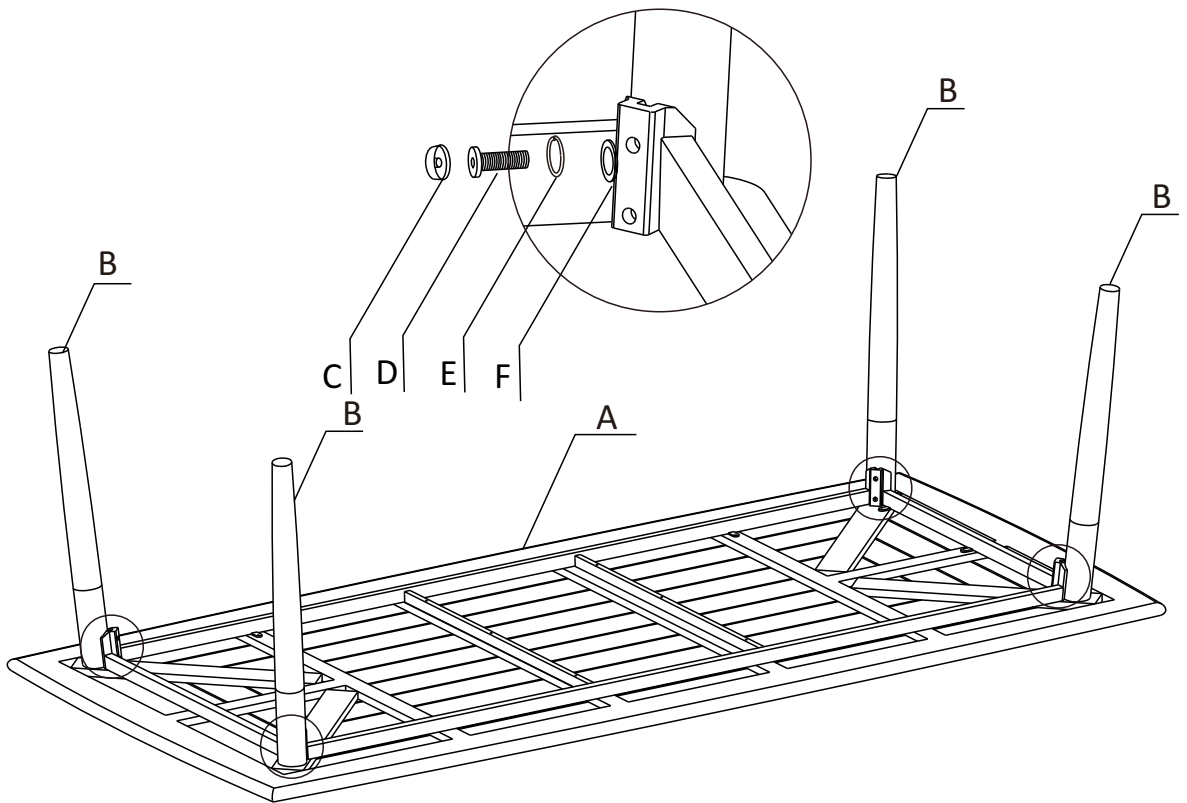

FURNITURE NOT SUITABLE FOR COMMERCIAL USE

STEP 2

FLIP THE TABLE OVER, YOUR TABLE IS READY FOR USE.

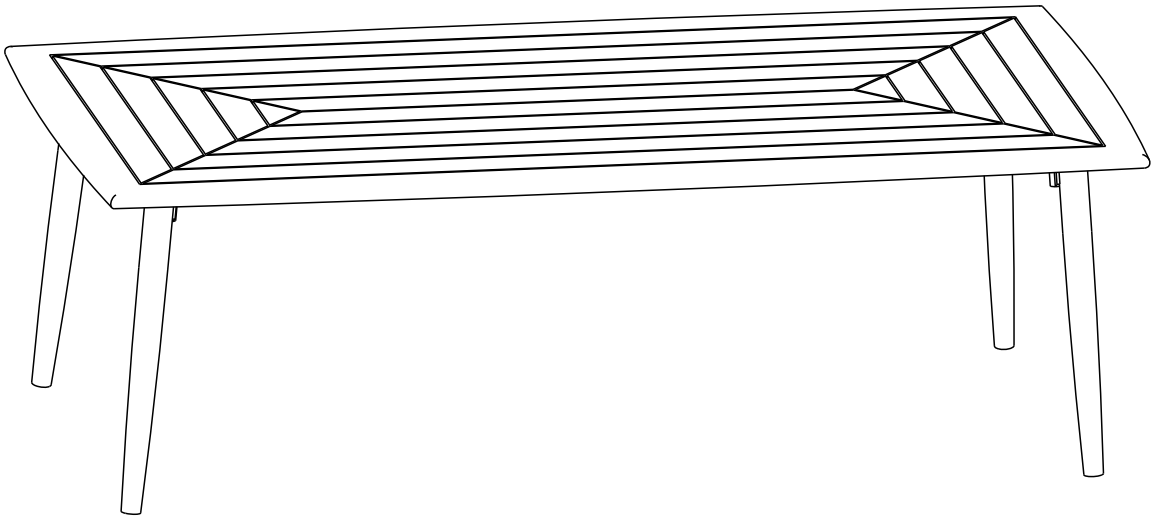

FURNITURE NOT SUITABLE FOR COMMERCIAL USE

Care and maintenance

GLASS & GRC TABLE TOPS:

- If chipped or broken, do not use the product and contact the place of purchase.
- Do not drop, drag or strike the surface.
- Do not sit or stand on the surface.
- Do not place very Hot or Cold items directly onto the surface – placemats / coasters are recommended to avoid damage.
- Do not place heavy items on glass.
- Do not strike the surface with hard or pointed items.
- Do not allow hot embers or direct flames to come close or in direct contact with surface.
- To protect the finish, avoid the use of abrasive chemicals, harsh cleaners, rough cleaning pads and polishes.

CHAIRS & STOOLS:

- Do NOT, use the chair or stool as a ladder.
- Do NOT, climb on the chair or stool.
- Do NOT, rock back and forth on the front and back legs of the chair or stool.

Failure to observe the above warnings may result in damage to your furniture and or serious injuries.

Wicker, Textiles, Rope:

Our wicker, textiles and rope furniture requires very little maintenance to keep it looking like new.
For daily care and spills:

- Simply wipe clean using a soft, dry cloth.
- To remove dirt and grime, simply rinse with fresh water or periodically clean using a sponge and mild detergent solution as required.
- To protect the finish, avoid the use of abrasive chemicals, harsh cleaners, rough cleaning pads and polishes.
- Do not allow hot embers or direct flames to come close or in direct contact with surface.

Failure to observe the above cleaning recommendations may result in premature UV damage and or fading to your furniture.

IN CASE OF DIRECT SUNLIGHT:

To guard against fading, any Outdoor Furniture exposed to direct sunlight or the everyday elements, we recommend:

- Storage of cushions when not in use.
- The use of a furniture cover.

Failure to observe the above recommendations may result in premature UV damage and or fading to your furniture.

RTA (READY TO ASSEMBLE) FURNITURE:

- Regular checking and tightening of all bolts is recommended for optimum performance and durability.
If not regularly checked and tightened, your furniture could become unstable.